

INSTALLATION MANUAL

APPLICATION

PI series is a 24 VAC/VDC Modulating Digital Thermostat that provides Proportional + Integral (P+I) control for optimum temperature control and comfort in HVAC system. It is used with the single fan speed. Other available features include selection of Minimum / Maximum setting temperature, Digital input for energy savings, Mode of display. The remote temperature sensor can also be provided as the optional.

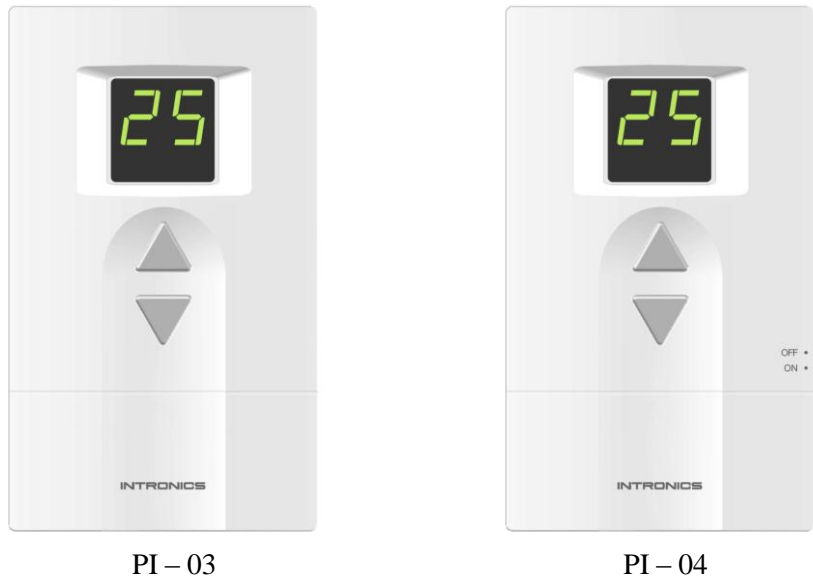

Fig.1 PI – 03 & 04

Table 1 : Description of Thermostat

Model	Mounting	Operating voltage	Type of control	Power on/off switch
PI – 03	Vertical	24 VAC	Modulating 0-10V or 2-10V	No
PI – 04	Vertical	24 VAC	Modulating 0-10V or 2-10V	Yes

FEATURES

- ❑ Stylish design with digital display.
- ❑ Minimum temperature setting from 5 – 23 °C (Default 11 °C).
- ❑ Maximum temperature setting from 16 – 34 °C (Default 30 °C).
- ❑ Compatible with 10 different characteristics of modulating valve/damper.
- ❑ Setting of calculating position cycle.
- ❑ K_p setting.
- ❑ T_i setting.
- ❑ Temperature offset –2 to +2 °C (Default 0 °C).
- ❑ Digital input for energy savings.
- ❑ Mode of display : Room temperature, Setting temperature or % of valve/damper opening.
- ❑ Remote sensor (optional) with auto detect of temperature sensor (internal or remote sensor).
- ❑ Sensor error alarm.
- ❑ EEPROM permanently retains user setting in case of power loss.

SPECIFICATIONS

Table 2 : Thermostat specifications

Power supply	24 Vac nominal, 18 – 30 Vac, 50/60 Hz. or 24 Vdc nominal, 18-30 Vdc
Electrical rating	0.8 Amp maximum
Temperature setting range	5 – 34 °C
Operating relative humidity	5 to 90 % RH, non condensing
Output	Modulating 0-10V or 2-10 V Direct/Reversing Actuating
Mounting	Directly onto wall or 2”x 4 “ vertical junction box

DIMENSIONS

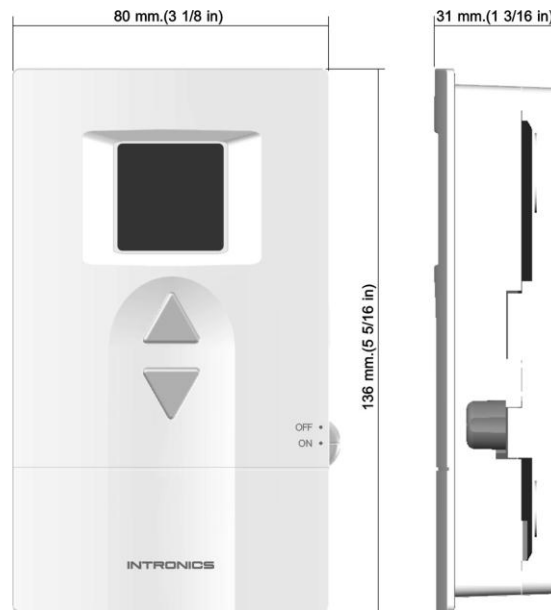

Fig.2 Dimensions

OPERATION

Power on off (for Model PI - 04 only)

Use ON/OFF switch to turn on / off the system.

Temperature setting

Use Δ or ∇ to change the temperature setting.

Minimum temperature set point

The system provides the facility to program the minimum setting point in a range of 5 – 23 °C (with 2 °C incremental).

Maximum temperature set point

The system provides the facility to program the maximum setting point in a range of 16 – 34 °C (with 2 °C incremental).

PI Control parameter

The system provides the facility to program the value of K_p and T_i .

Temperature offset

The temperature offset can be set in a range of -2 to $+2$ °C.

Display mode

The Display can be programmed to display room temperature, setting temperature or % of valve/damper opening.

Temperature display in decimal number

In case of selecting program 8.0 and 9.1, Press Δ and ∇ key simultaneously to toggle showing room temperature in integer or decimal number. To exit this program, cut off the power.

Remote sensor (optional)

The Remote sensor can be provided as the optional. It can be the temperature module, epoxy or pipe type. The system will automatically detect whether the internal or the Remote sensor is used.

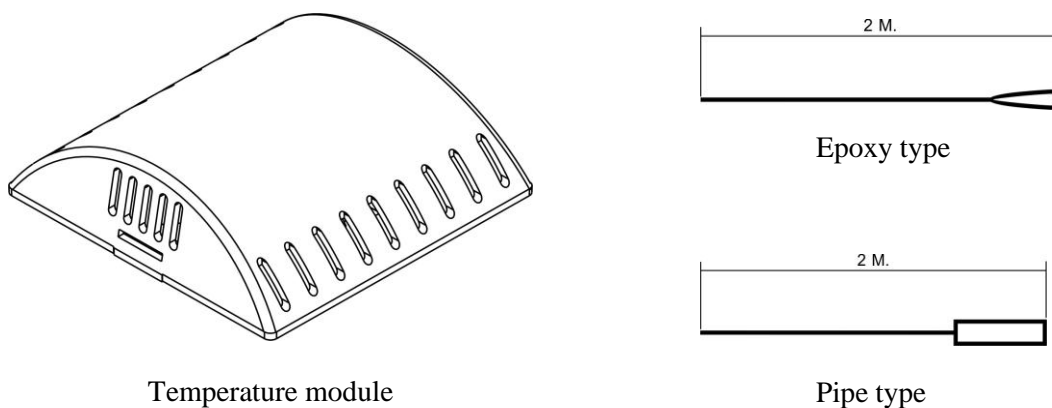

Fig.3 Remote sensor

Specify the type of Remote sensor when order.

Digital input for energy savings

There is a Digital input port for energy savings provided in the system. If the input is NO contact, the system will not do anything. If the input is NC contact, it will delay for 2 minutes and then



- raise up the setting temperature for 2 °C, and
- activate the dot LED after the second digit as an alarm.

Sensor error alarm

If the temperature sensor (either internal or remote) is failed, Display will show $E \Upsilon$ in blinking.

Target error alarm

If the target of the valve/damper opening can not be reached within 2 minutes (for Feed back type only), Display will show $E \text{f}$ in blinking.

INSTALLATION

Read these instructions thoroughly before installing product. Failure to follow these instructions could damage the product or cause a hazardous condition. Check the voltage and current ratings on the product to ensure that it is suitable for your application. Installer must be a trained, experienced service technician. Check product for proper operation after installation.



CAUTION
Damage to cooling system may occur.
Disconnect power from the equipment at the main breaker/fuse block while installing the thermostat.

Mounting Location.

Mount the thermostat approximately 5 ft. (1.5 m) above the floor in a location that is free from direct sunlight, heat from appliances, hot or cold air from ducts, concealed pipes and chimneys, and drafts or dead spots behind doors or in corners. Do not mount on exterior wall, if possible. Failure to locate thermostat mounting as indicated will result in poor temperature control.

NOTE: Level thermostat mounting is for appearance only and is not required for proper thermostat operation.

Mounting Thermostat

Take out the back plate by removing the locking screw (if any) at the bottom of the thermostat. Use flat head screw driver to unlock the snaps. Lift and pull it up to remove back plate.

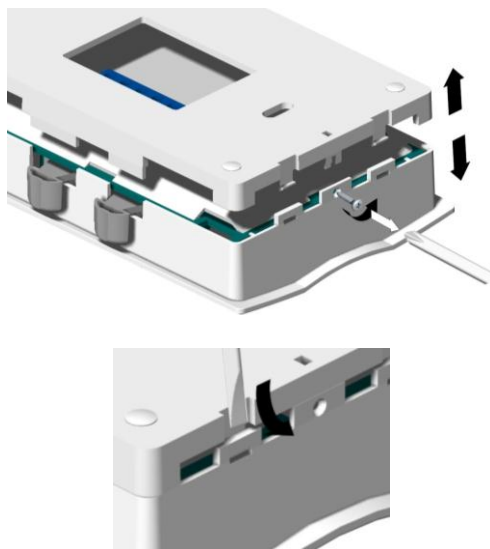

Fig.4 Taking out back plate

Using back plate as a guide, mark two mounting holes on the wall. Drill two mounting holes. Place anchors (provided) into the holes until flush with the hole. Position back plate on the wall and thread the wires from the heating and cooling equipment through the wiring hole. Holding the back plate in place on the wall, secure it to the wall using mounting screws (provided).

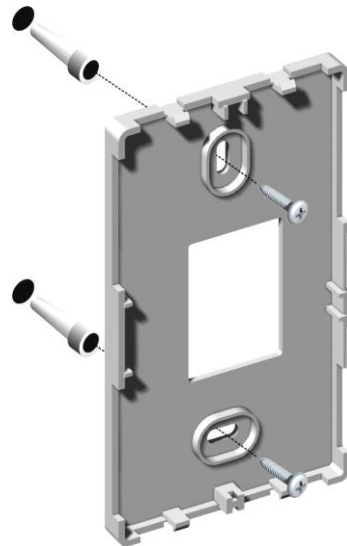

Fig.5 Installing back plate

Wiring

Pull the connector from the back of thermostat by inserting screw driver at the base of connector and gently lift up.

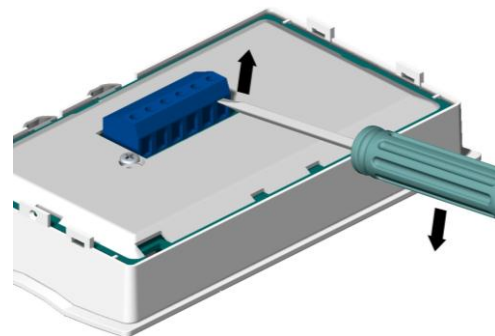

Fig.6 Lifting the connector

The 18-22 gauge wire is recommended for wiring.

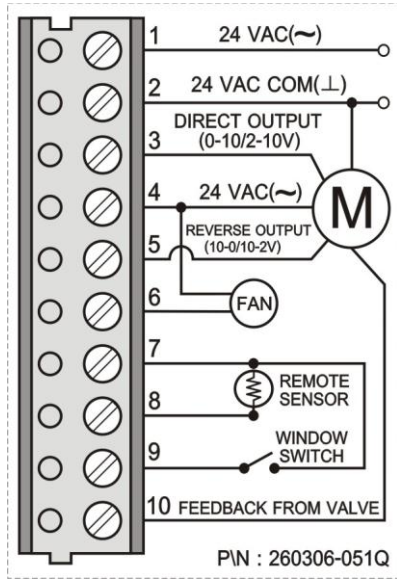

Fig.7 Wiring diagram

Place the terminal back to the thermostat, make sure it has the same orientation like in the picture described at the back. Snap the thermostat to its back plate.



Fig.9 Installing thermostat

Note : Only one terminal from terminals 3&5 is connected. It is subjected to the application.

Loosen the terminal screw, strip the wire and connect the wire as shown in fig. 8 Firmly tighten terminal screw when finished.

Secure the thermostat by tightening the screw provided to protect the thermostat from unwanted access.

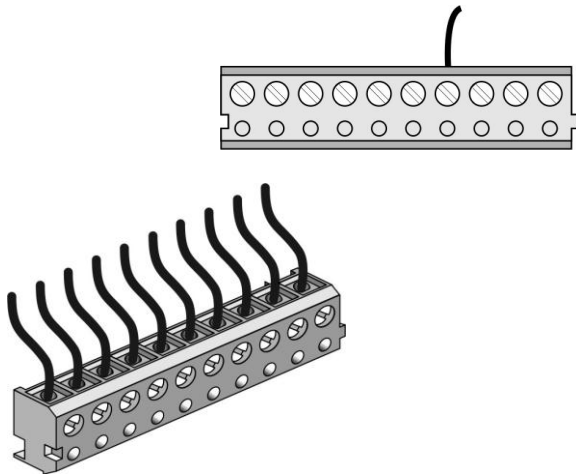

Fig.8 Connecting wire



Fig.10 Secure the front cover

INSTALLER SETUP

The following instructions provide information to test the cooling equipment and to change operating parameters from the factory settings.

Enter Installer Setup

Press and hold Δ and ∇key simultaneously for 10 seconds to enter installer setup. The dot between the two digit display lits showing the Installer Setup mode.



The first digit shows the Programming number.
The second digit shows the Parameter setting.

Now follow the following steps to change each of the settings. Each time you press Δ key, you will advance to the next Programming number. The ∇key is used for Parameter setting.

Program 1 : Minimum temperature setting

To set the minimum temperature (5-23 °C) allowed for the user.



- ❑ Press Δ key until the first digit is 1.
- ❑ Press ∇key until the second digit is as required. See table below.

Second digit displays	0	1	2	3	4	5	6	7	8	9
Min. temp. setting	5	7	9	11	13	15	17	19	21	23

Note : Default setting is 11°C.

Program 2 : Maximum temperature setting

To set the maximum temperature (16-34 °C) allowed for the user.

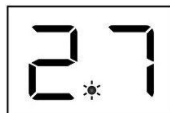

- ❑ Press Δ key until the first digit is 2.
- ❑ Press ∇key until the second digit is as required. See table below.

Second digit displays	0	1	2	3	4	5	6	7	8	9
Max. temp. setting	16	18	20	22	24	26	28	30	32	34

Note : Default setting is 30°C.

Program 3 : Type of valve/damper

There are several types of valve/damper subject to the types actuating, feed back and direction. Program the thermostat to match with the type of valve/damper used.



- ❑ Press Δ key until the first digit is 3.
- ❑ Press ∇ key until the second digit is as required. See table below.

Second digit displays	0	1	2	3	4	5	6	7	8	9
Type of actuating	0-10V	2-10V	0-10V	2-10V	0-10V	2-10V	0-10V	2-10V	0-10V	2-10V
Type of feed back	0-10V	0-10V	2-10V	2-10V	0-10V	0-10V	2-10V	2-10V	None	None
Feed back direction	DA	DA	DA	DA	RA	RA	RA	RA	None	None

Note : DA = Direct actuating, RA = Reverse actuating
 Factory setting is 3.8 (0-10 V actuating, No feed back).

Program 4 : Setting of Calculating position cycle

This program is used to select interval time of position calculation for valve control. It can be set in a range of 30-120 seconds. The control will delay the next operation of the valve/damper until the current operation is completed.



- ❑ Press Δ key until the first digit is 4.
- ❑ Press ∇ key until the second digit is as required. See table below.

Second digit displays	0	1	2	3	4	5	6	7	8	9
Opening time (sec.)	30	40	50	60	70	80	90	100	110	120

Note : Default setting is 40 seconds..

Program 5 : K_p setting

K_p is the proportional factor that control the opening of the valve/damper. The higher K_p , the faster the room temp. is brought to the set temp. However the fluctuation of the room temp. is also higher. Then K_p shall be set properly.



- ❑ Press Δ key until the first digit is 5.
- ❑ Press ∇ key until the second digit is as required. See table below.

Second digit displays	0	1	2	3	4	5	6	7	8	9
K_p	1	2	4	6	8	10	12	14	16	18

Note : Default setting is 5 ($K_p = 10$).

Program 6 : T_i setting

T_i is the integral factor that control the opening of the valve/damper. The higher T_i , the slower the room temp. is brought to the set temp. However the fluctuation of the room temp. is less. Then T_i shall be set properly.

- Press Δ key until the first digit is 6.
- Press ∇ key until the second digit is as required. See table below.



Second digit displays	0	1	2	3	4	5	6	7	8	9
T_i	40	50	60	70	80	90	100	120	160	200

Note : Default setting is 4 ($T_i = 80$).

Program 7 : Temperature offset

The temperature offset of the sensor’s reading can be set in a range of -2 to 2 °C with the resolution of 0.5 °C.

- Press Δ key until the first digit is 7.
- Press ∇ key until the second digit is as required. See table below.



Second digit displays	0	1	2	3	4	5	6	7	8
Offset temp. (°C)	-2	-1.5	-1	-0.5	0	0.5	1	1.5	2

Note : Default setting is 0 °C.

Program 8 : Display mode

The user can set the Display to show

- Room temperature or
- Set temperature or
- Valve/damper opening in % (by controller’s command)
- Valve/damper opening in % (by actual). This can not be applied if No feed back type is used. Display will show 00.
- Press Δ key until the first digit is 8.
- Press ∇ key until the second digit is as required. See table below.



Second digit displays	0	1	2	3
Display	Room temp.	Set temp.	% valve/damper (controller’s command)	% valve/damper (actual)

Note : Default setting is 0 (Room temp).

Program 9 : Temperature display in decimal number

The user can set the temperature display to show

- Integer number
- Decimal number
- Press Δ key until the first digit is 9.
- Press ∇ key until the second digit is as required. See table below.



Second digit displays	0	1
Display	Integer number	Decimal number

Note : Default setting is 0 (Integer number).