

## APPLICATION

GC-1000 is an Energy Savings Controller designed for hotel applications. It is used to control the air conditioner, lighting and outlets.

## INSTALLATION

Read these instructions thoroughly before installing product. Failure to follow these instructions could damage the product or cause a hazardous condition. Check the voltage and current ratings on the product to ensure that it is suitable for your application. Installer must be a trained, experienced service technician. Check product for proper operation after installation.

### CAUTION

Damage to the system may occur. Disconnect power from the equipment at the main breaker/fuse block while installing the system.

#### Key box

Take out the steel plate by removing the locking clip at the bottom of the box. Then inserting screwdriver between the plastic and steel plate, gently lift up.

Mount the plate on the 3"x 3" box using the screws (provided), make sure it has the same orientation as shown in Fig.2.



Fig.1: Take out steel plate



Fig.2: Mount the plate

Take out the connector from the PCB and extend the 2 wires to the location of the Main control box.

Note that extra wire has to be spliced in depending on the distance from the key box to the main unit. See Fig 9 for wiring diagram.

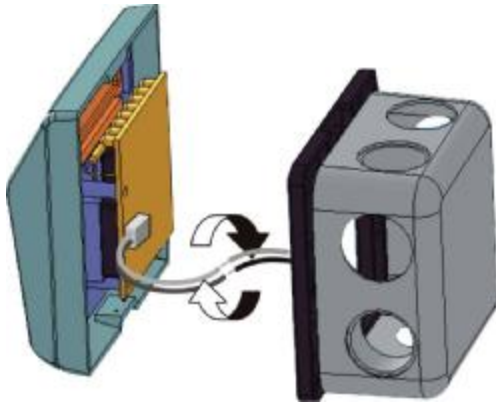

Fig.3: Extend the wires

Snap the Key box to its steel plate and secure it with the clip.



Fig.4: Snap & Secure the box

### Display Unit

Take out the front cover by inserting the flat head screwdriver to unlock the snaps. Lift and pull it up to remove front cover.

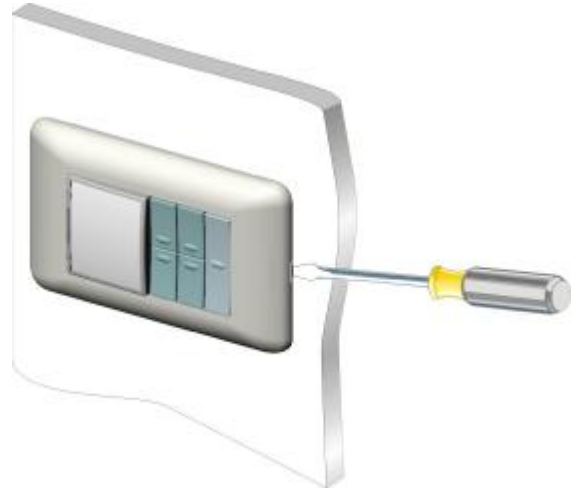

Fig.5: Taking out front cover

Use 6 core cable size 0.5 sq.mm. to connect the wires from the Main control box to the terminals on the display unit.

Note that extra wire has to be spliced in depending on the distance from the Display Unit to the main unit. See Fig 9 for wiring diagram.

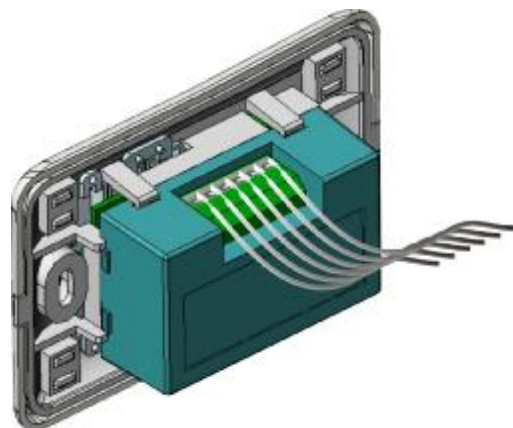
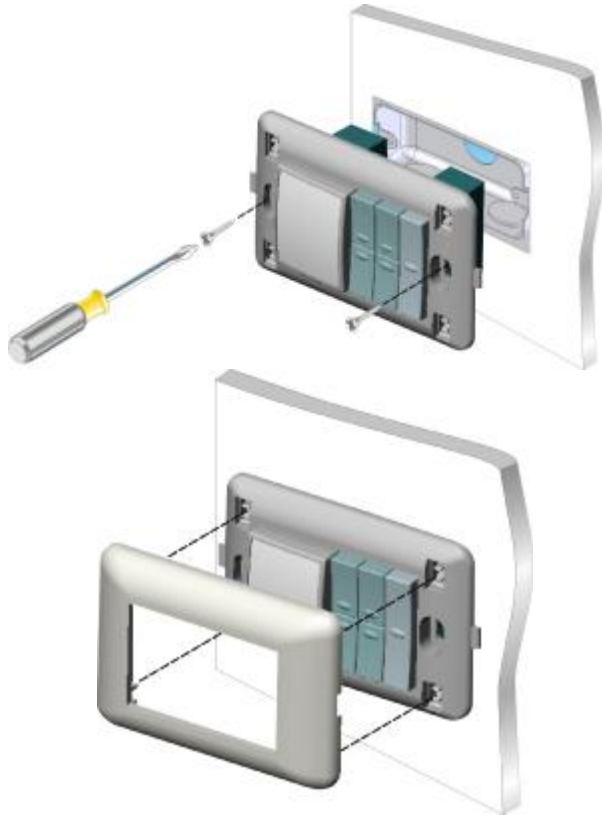

Fig.6: Wiring for display unit

Mount the display unit to a 4"x 2" box and snap the front cover to the unit.



### Main control box

Using Main control box as a guide, mark four mounting holes on the wall. Drill four mounting holes. Place anchor (provided) into the holes until flush with the hole. Holding the box in place on the wall, secure it to the wall using mounting screws (provided).

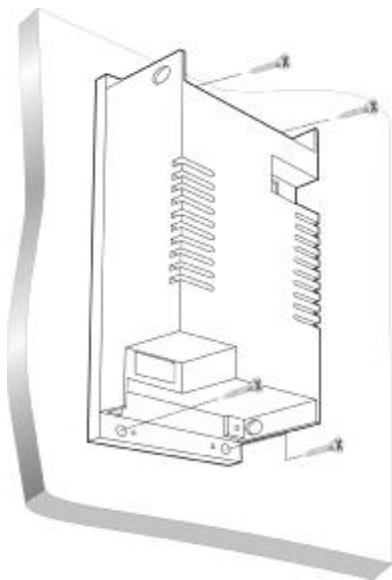

Fig.7: Mount the Main control box

### Wiring to the Key box

The connector with 2 wires are provided at P15 pins. Connect these 2 wires to the cable run from the Key box.

### Wiring to Thermostat

The 6 pin screw type connector is provided. Connect the 6 core cable running from the Display Unit to this connector in the correct sequence.

### Wiring to Balcony sensor

Install the Balcony sensor (provided) at the door or window as per Fig.8.

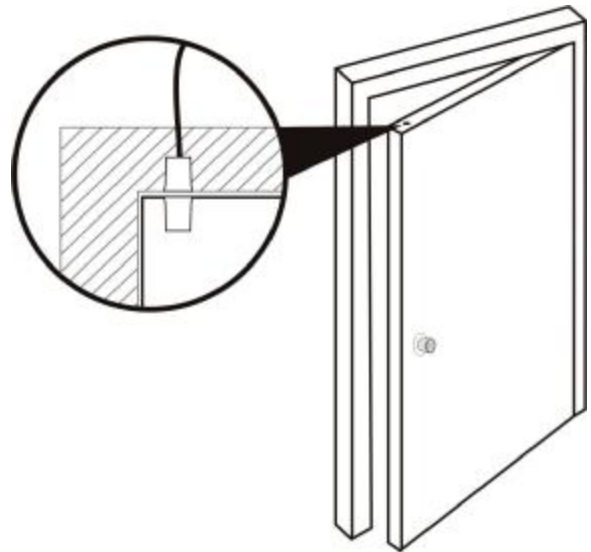

Fig.8: Install the Balcony sensor

Extend the sensor wires with the same size wires and run to the Main control box.

The connector with 2 wires are provided at P16 pins. Connect these to the wires run from the Balcony sensor.

### Wiring to the equipment and supply

Use cable size 0.5-1 sq.mm. to connect from the terminals on the Main control box to

- cooling equipment
- fan motor
- lighting & outlet
- power supply

## WIRING DIAGRAM

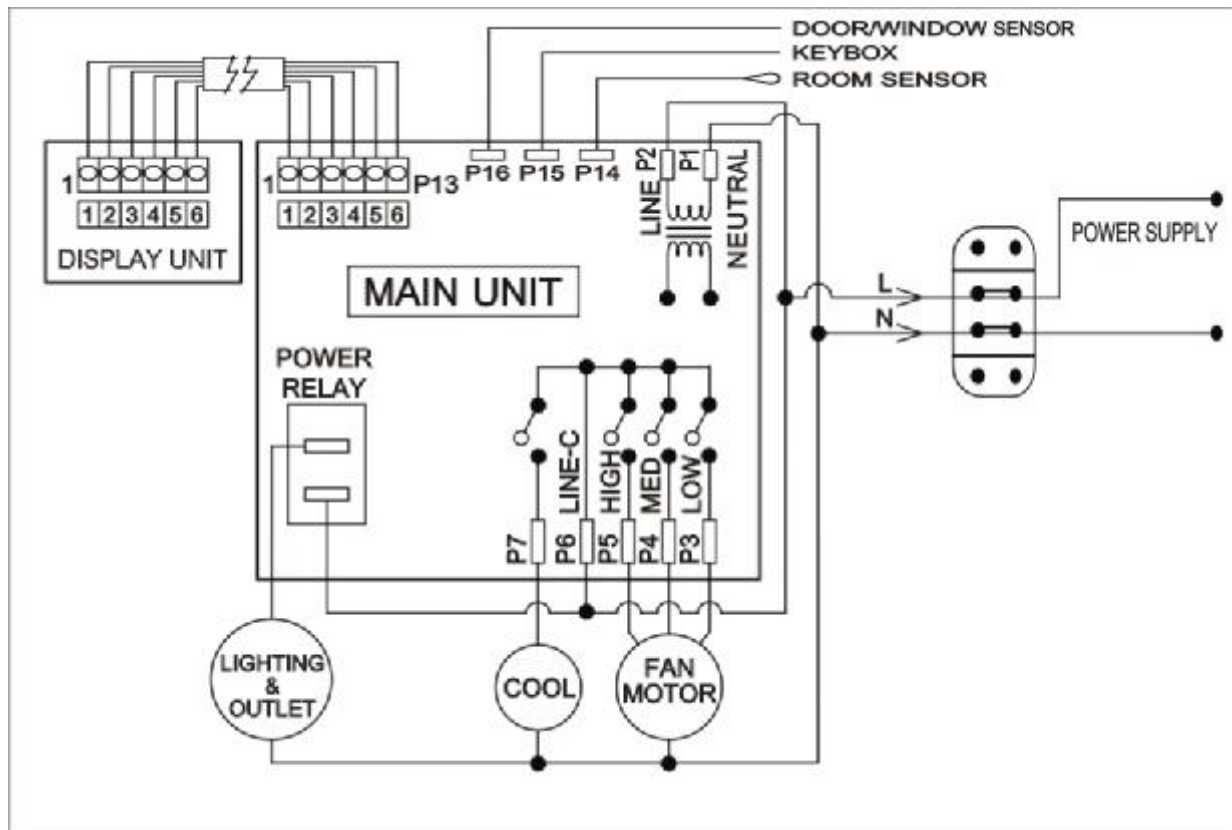

Fig.9: Wiring diagram

## SPECIFICATION

<b>POWER SUPPLY</b>	
GC1000-001 / 120 VAC system	105 – 128 VAC, 50/60 Hz
GC1000-002 / 220 VAC system	198 – 250 VAC, 50/60 Hz
<b>TEMPERATURE</b>	
Storage temperature	0 – 70 °C
Ambient temperature	10 – 50 °C
Setting temperature range	19 – 30 °C (64 – 88 °F) or 21 – 30 °C (70 – 88 °F)
<b>RELAY RATING</b>	
Lighting & Outlets	20 A (resistive load)
Air conditioner (comp. & fan)	5 A (resistive load)

**SET UP**

Failure to set up according to the application may damage the system.

**Hardware setup**

When the Key tag is pulled out from the Key box, there will be a time delay before the Energy savings operation is activated. This time delay can be chosen by using the jumpers at OP1& 2 location (default setting is 30 seconds)



- Insert jumper at OP1 location only, time delay is 30 seconds.
- Insert jumper at OP2 location only, time delay is 60 seconds.
- No jumper on both OP1 & OP2 location, time delay is 90 seconds.

**Software setup**

<b>Option</b>	<b>Setting</b>	<b>Default setting</b>
<i>P1</i>	Energy savings operation <input type="checkbox"/> turn off air conditioning system, or <input type="checkbox"/> raise up the temperature 2°C (or 4°F) and fan in low speed	Raise up temperature
<i>P2</i>	Low limit temperature <input type="checkbox"/> 19°C (or 67°F) <input type="checkbox"/> 21°C (or 70°F)	21°C (or 70°F)
<i>P3</i>	Temperature display <input type="checkbox"/> display sensed temperature <input type="checkbox"/> display set point only	Display sensed temperature
<i>P4</i>	Compressor delay time (3 minutes) <input type="checkbox"/> no time delay <input type="checkbox"/> with time delay	No time delay
<i>P5</i>	Door/Window (Balcony) time delay <input type="checkbox"/> 15 seconds <input type="checkbox"/> 60 seconds	60 seconds





### Entering Setup Mode

Before selecting the option(s), the following steps must be done

- ❑ While the Key card is inserted in the Key box, press  button to turn off the air conditioner.
- ❑ Press and hold  +  button for 3 seconds, the display shows *P1* in blinking.





### Energy savings operation

This option is to select the operation of the air conditioner when the Key card is pulled out from the Key box or the Door/window is left opened.

- ❑ Press  or  button until the Display shows *P1*.
- ❑ Press  button, the **COOL** LED is lit. This selection turns off the air conditioning system (comp/valve OFF, fan OFF), or
- ❑ Press  button, the **HEAT** LED is lit. This selection raises the setting temperature up 2°C (or 4°F) and fan is put in low speed





### Low limit temperature setting

This option is to select the lowest temperature setting of 19°C (or 67°F) / 21°C (or 70°F).

- ❑ Press  or  button until the Display shows *P2*.
- ❑ Press  button, the **COOL** LED is lit. This selection is for choosing 19°C (or 67°F), or
- ❑ Press  button, the **HEAT** LED is lit. This selection is for choosing 21°C (or 70°F).





### Temperature display

This option is to select whether the Display unit shows the sensed temperature or the set point only.

- ❑ Press  or  button until the Display shows *P3*.
- ❑ Press  button, the **COOL** LED is lit. This selection is to display the sensed temperature, or
- ❑ Press  button, the **HEAT** LED is lit. This selection is to display the set point only.





### Compressor delay time

This option is to select whether the 3 minute compressor delay time is needed.

- Press  or  button until the Display shows *P4*.
- Press  button, the **COOL** LED is lit. This selection is to cancel the time delay.
- Press  button, the **HEAT** LED is lit. This selection is to choose the time delay.

### Door/Window time delay

This option is to set the time delay for the energy savings mode when the door/window is left open.

- Press  or  button until the Display shows *P5*.
- Press  button, the **COOL** LED is lit. This selection is to select 15 seconds time delay.
- Press  button, the **HEAT** LED is lit. This selection is to select 60 seconds time delay.

## USER INTERFACE

### Key box

When the Key tag is pulled out from the Key box, the Energy savings operation is activated. After the time delay the system will

- turn off the power supplied to the lightings & outlets circuit, and
- turn off the air conditioner or raise up the temperature and put the fan in a low speed (Program *P1*).



### DISPLAY UNIT

The buttons on the Display unit are used for

#### Power on/off

Press  button to turn on/off the air conditioner.

#### Temperature setting

Press  or  button to set the temperature in a range of 19-30°C (or 64-88°F) or 21-30°C (70-88°F) subject to the lowest temperature programmed.

**Fan**

Press  button to select the fan speed (high, medium, low or auto mode). The Display unit will show the status.

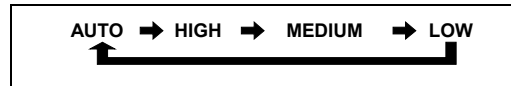
**Auto mode**

When the fan speed is put in auto mode, the speed will be adjusted automatically according to the difference between the room temperature and setting temperature.

- If the difference is 3°C or more, the fan speed is high.
- If the difference is 2°C, the fan speed is medium.
- If the difference is 1°C or less, the fan speed is low.

**°C/°F**

Press  button to change the temperature display from °C to °F or vice versa.